

Bohrstar 54



BORING KITS from $\varnothing 6$ mm up to 210 mm



Coupling system

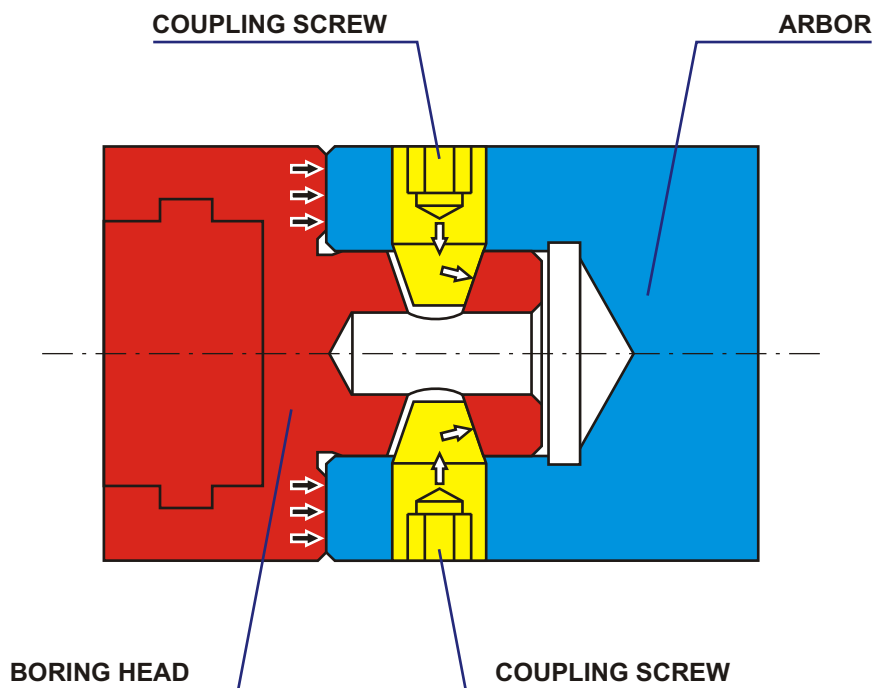

HIGH RIGIDITY

By tightening the two cone shaped coupling screws, high axial forces are developed in the tapered holes of the pilot shank. These axial forces preload the contact surface between the flange faces of the coupled components with high axial pressure for ample support against lateral loads. It can also dampen vibrations.

POSITIVE TOOL ORIENTATION

The locating pin guarantees repeat positioning between components at all times.

All arbors, extensions and reducers are shipped complete with coupling screws.

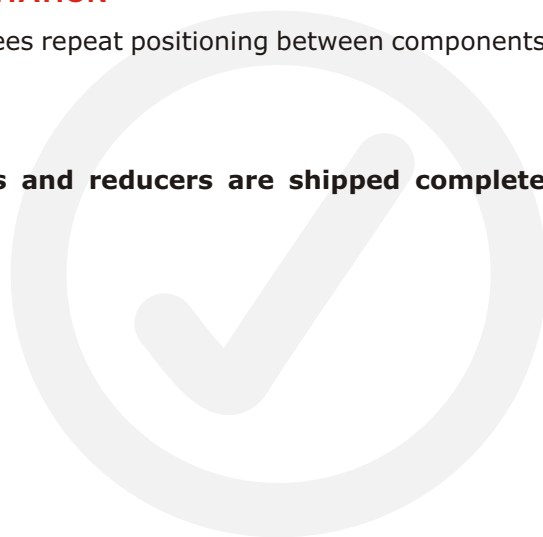

MAS BT 403
page 16

DIN 69871
page 17

DIN 2080
page 18

DIN 69893
HSK - A
page 19

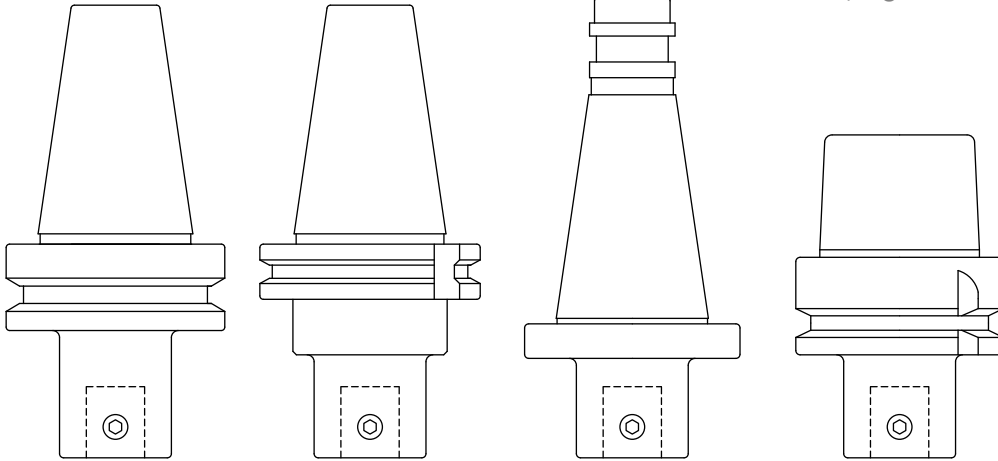

ACCESSORIES
page 20

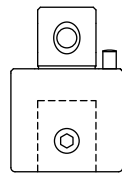

BORING HEAD
page 20

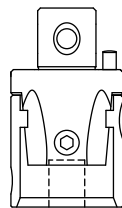

BORING BARS
page 21

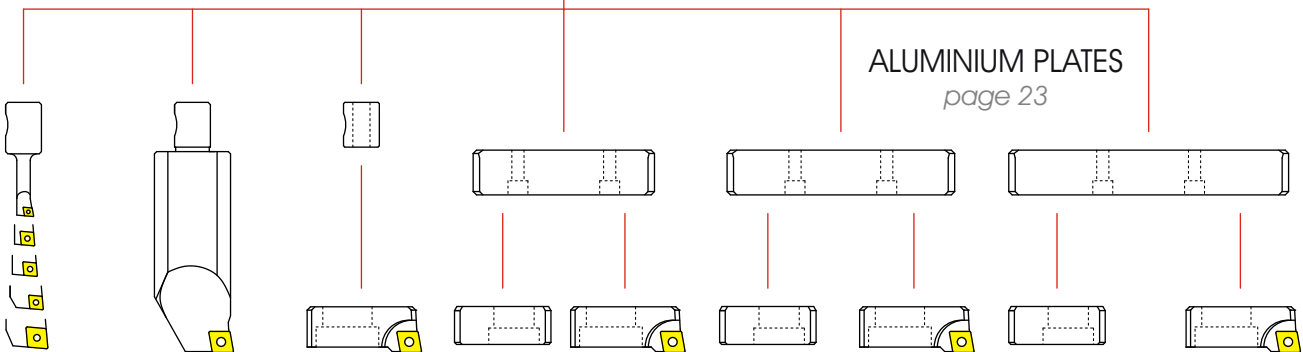

CARTRIDGES
page 22

Bohrstar 54 KIT

Rhombic insert 

Ø 6 - 43



ORDERING NUMBER:
BS 54 KIT R 6-043

	Description	Product Number	Qty.
1	Bohrstar head	BS 054 16	1
	Boring bar 5 mm.	BS 05 16 R01	1
	Boring bar 6 mm.	BS 06 16 R01	1
2	Boring bar 8 mm.	BS 08 16 R03	1
	Boring bar 10 mm.	BS 10 16 R03	1
	Boring bar 12 mm.	BS 12 16 R03	1
	Boring bar 16 mm.	BS 16 16 R04	1

	Description	Product Number	Qty.
3	Hexagonal key 3	HK 030	1
	Hexagonal key 5	HK 050	1
	Hexagonal key 6	HK 060	1
4	Torx key 6	TK 06	1
	Torx key 8	TK 08	1
	Torx key 15	TK 15	1

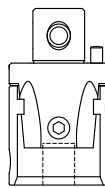

From Ø 6
To Ø 43

Bohrstar 54 KIT

Rhombic insert 

Ø 8 - 43



ORDERING NUMBER:
BS 54 KIT R 8-043

	Description	Product Number	Qty.
1	Bohrstar head	BS 054 16	1
	Boring bar 6 mm.	BS 06 16 R01	1
	Boring bar 8 mm.	BS 08 16 R03	1
2	Boring bar 10 mm.	BS 10 16 R03	1
	Boring bar 12 mm.	BS 12 16 R03	1
	Boring bar 16 mm.	BS 16 16 R04	1

	Description	Product Number	Qty.
3	Hexagonal key 3	HK 030	1
	Hexagonal key 5	HK 050	1
	Hexagonal key 6	HK 060	1
4	Torx key 6	TK 06	1
	Torx key 8	TK 08	1
	Torx key 15	TK 15	1

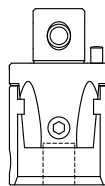

From Ø 8
To Ø 43

Bohrstar 54 KIT

Rhombic insert 

Ø 6 - 100



ORDERING NUMBER:
BS 54 KIT R 6-100

	Description	Product Number	Qty.
1	Bohrstar head	BS 054 16	1
	Boring bar 5 mm.	BS 05 16 R01	1
	Boring bar 6 mm.	BS 06 16 R01	1
2	Boring bar 8 mm.	BS 08 16 R03	1
	Boring bar 10 mm.	BS 10 16 R03	1
	Boring bar 12 mm.	BS 12 16 R03	1
	Boring bar 16 mm.	BS 16 16 R04	1
3	Boring bar 34 mm.	BS 34 16 R04	1
4	Cartridge	BS 2CT R04	1

	Description	Product Number	Qty.
5	Location sleeve	BS 16 M10	1
6	Hexagonal key 3	HK 030	1
	Hexagonal key 5	HK 050	1
	Hexagonal key 6	HK 060	1
7	Hexagonal key 8	HK 080	1
	Torx key 6	TK 06	1
	Torx key 8	TK 08	1
8	Torx key 15	TK 15	1
	Cartridge screw	CS 10 25	1

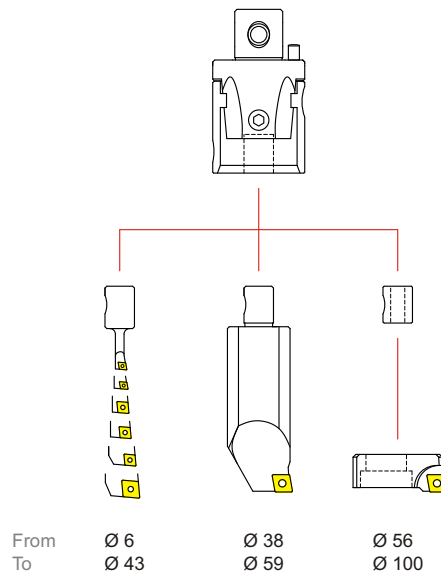

Bohrstar 54 KIT

Rhombic insert 

Ø 8 - 100



ORDERING NUMBER:
BS 54 KIT R 8-100

	Description	Product Number	Qty.
1	Bohrstar head	BS 054 16	1
	Boring bar 6 mm.	BS 06 16 R01	1
	Boring bar 8 mm.	BS 08 16 R03	1
2	Boring bar 10 mm.	BS 10 16 R03	1
	Boring bar 12 mm.	BS 12 16 R03	1
	Boring bar 16 mm.	BS 16 16 R04	1
3	Boring bar 34 mm.	BS 34 16 R04	1
4	Cartridge	BS 2CT R04	1
5	Location sleeve	BS 16 M10	1

	Description	Product Number	Qty.
	Hexagonal key 3	HK 030	1
6	Hexagonal key 5	HK 050	1
	Hexagonal key 6	HK 060	1
	Hexagonal key 8	HK 080	1
	Torx key 6	TK 06	1
7	Torx key 8	TK 08	1
	Torx key 15	TK 15	1
8	Cartridge screw	CS 10 25	1

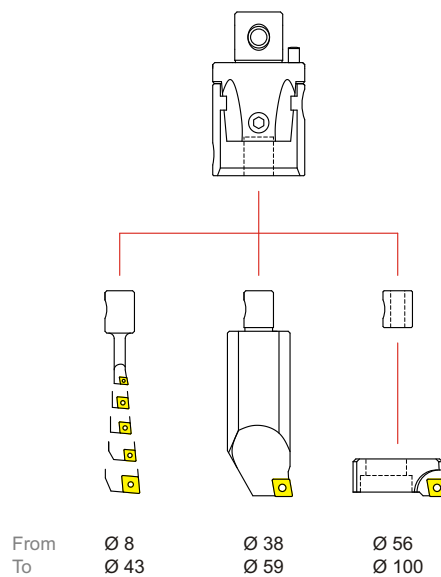

Bohrstar 54 KIT

Rhombic insert 

Ø 6 - 170

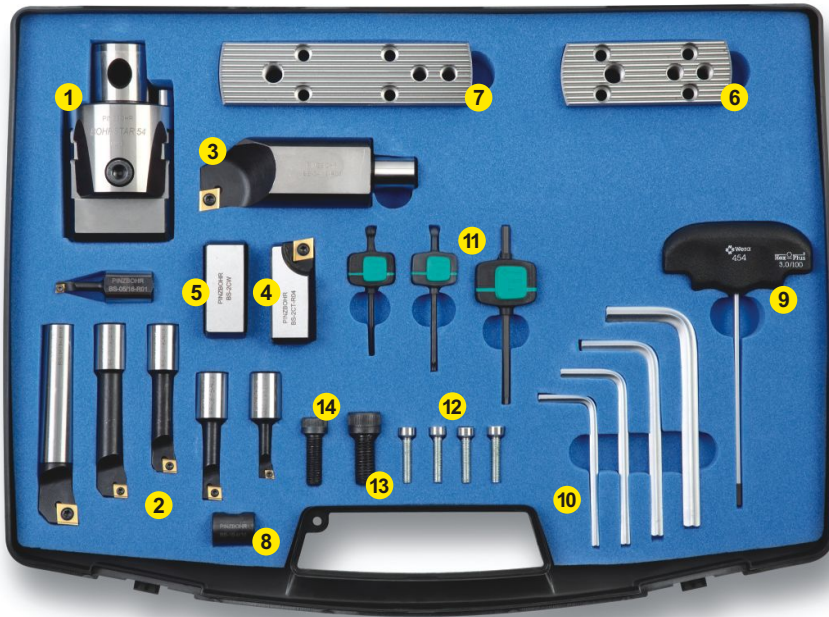

ORDERING NUMBER:
BS 54 KIT R 6-170

Description	Product Number	Qty.	Description	Product Number	Qty.
1 Bohrstar head	BS 054 16	1	8 Location sleeve	BS 16 M10	1
2 Boring bar 5 mm.	BS 05 16 R01	1	9 Adjusting key	AK 03	1
3 Boring bar 6 mm.	BS 06 16 R01	1	10 Hexagonal key 4	HK 040	1
4 Boring bar 8 mm.	BS 08 16 R03	1	11 Hexagonal key 5	HK 050	1
5 Boring bar 10 mm.	BS 10 16 R03	1	12 Hexagonal key 6	HK 060	1
6 Boring bar 12 mm.	BS 12 16 R03	1	13 Hexagonal key 8	HK 080	1
7 Boring bar 16 mm.	BS 16 16 R04	1	14 Torx key 6	TK 06	1
8 Boring bar 34 mm.	BS 34 16 R04	1	9 Torx key 8	TK 08	1
9 Cartridge	BS 2CT R04	1	10 Torx key 15	TK 15	1
10 Counterweight	BS 2CW	1	11 Plate fixing screws	D 027 21	4
11 Small plate	BS SP 085 130	1	12 Cartridge screw	CS 10 25	1
12 Medium plate	BS SP 125 170	1	13 Counterweight screw	CS 08 25	1

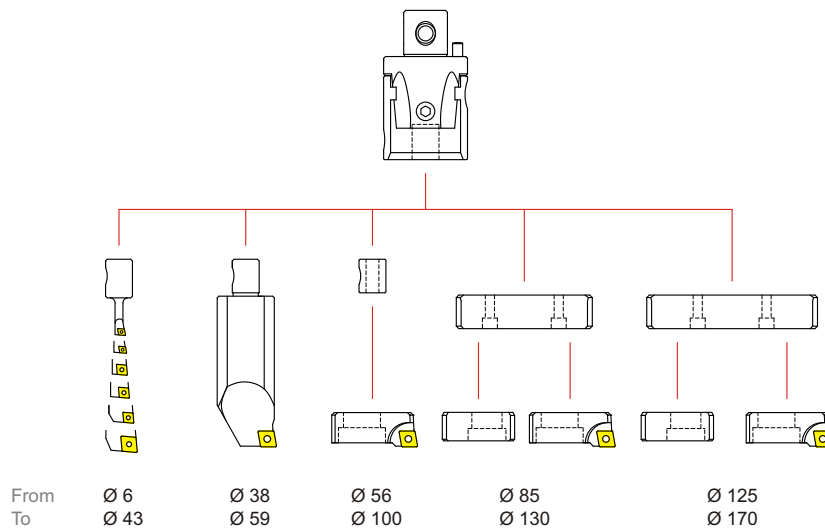

Bohrstar 54 KIT

Rhombic insert 

Ø 8 - 170

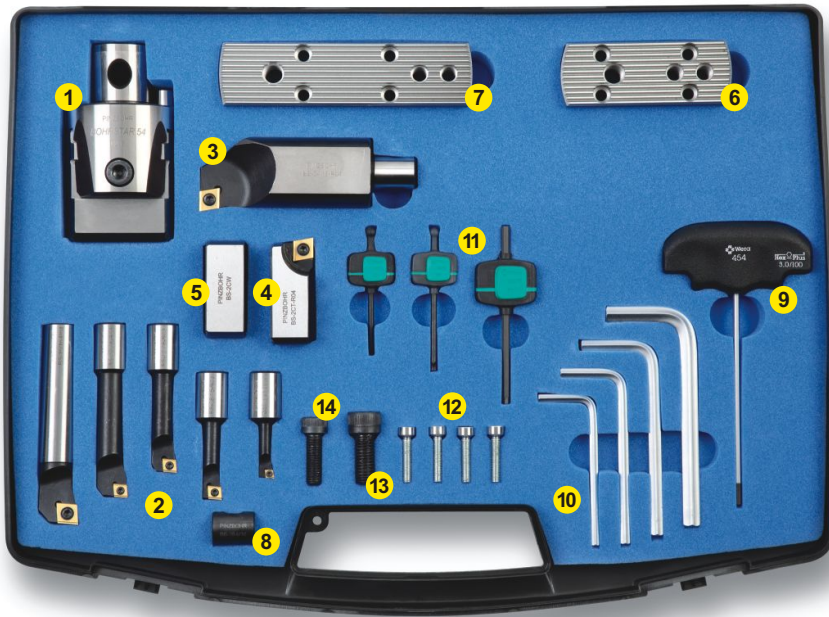

ORDERING NUMBER:
BS 54 KIT R 8-170

	Description	Product Number	Qty.
1	Bohrstar head	BS 054 16	1
	Boring bar 6 mm.	BS 06 16 R01	1
	Boring bar 8 mm.	BS 08 16 R03	1
2	Boring bar 10 mm.	BS 10 16 R03	1
	Boring bar 12 mm.	BS 12 16 R03	1
	Boring bar 16 mm.	BS 16 16 R04	1
3	Boring bar 34 mm.	BS 34 16 R04	1
4	Cartridge	BS 2CT R04	1
5	Counterweight	BS 2CW	1
6	Small plate	BS SP 085 130	1
7	Medium plate	BS SP 125 170	1
8	Location sleeve	BS 16 M10	1

	Description	Product Number	Qty.
9	Adjusting key	AK 03	1
	Hexagonal key 4	HK 040	1
	Hexagonal key 5	HK 050	1
10	Hexagonal key 6	HK 060	1
	Hexagonal key 8	HK 080	1
	Torx key 6	TK 06	1
11	Torx key 8	TK 08	1
	Torx key 15	TK 15	1
12	Plate fixing screws	D 027 21	4
13	Cartridge screw	CS 10 25	1
14	Counterweight screw	CS 08 25	1

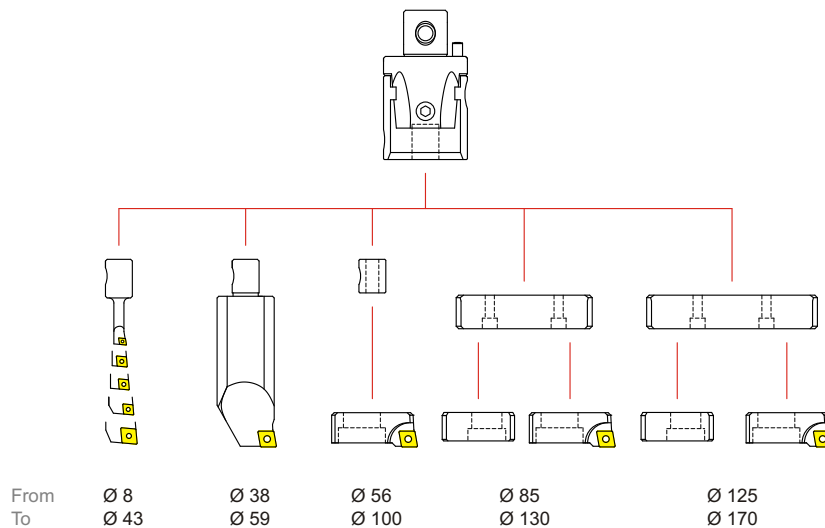

Bohrstar 54 KIT

Rhombic insert 

Ø 6 - 210

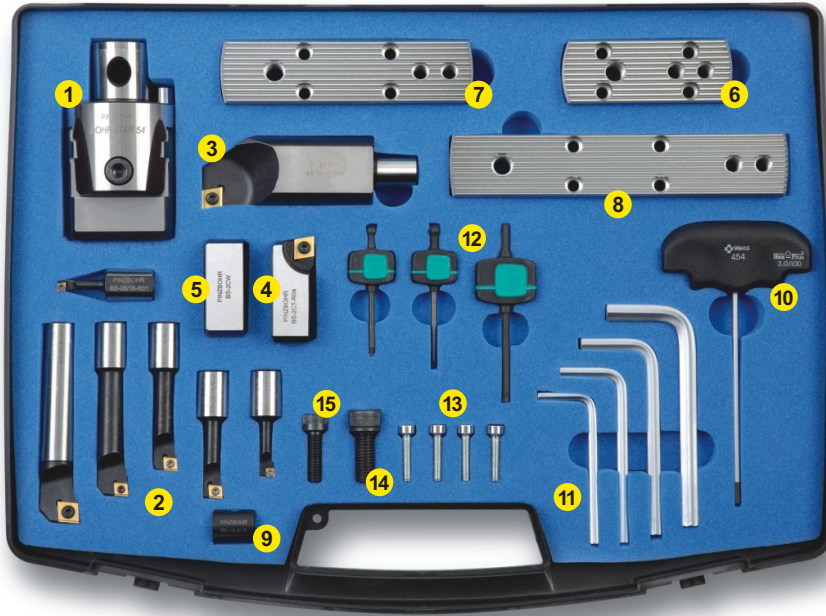

ORDERING NUMBER:
BS 54 KIT R 6-210

Description	Product Number	Qty.	Description	Product Number	Qty.
1 Bohrstar head	BS 054 16	1	9 Location sleeve	BS 16 M10	1
2 Boring bar 5 mm.	BS 05 16 R01	1	10 Adjusting key	AK 03	1
3 Boring bar 6 mm.	BS 06 16 R01	1	11 Hexagonal key 4	HK 040	1
4 Boring bar 8 mm.	BS 08 16 R03	1	12 Hexagonal key 5	HK 050	1
5 Boring bar 10 mm.	BS 10 16 R03	1	13 Hexagonal key 6	HK 060	1
6 Boring bar 12 mm.	BS 12 16 R03	1	14 Hexagonal key 8	HK 080	1
7 Boring bar 16 mm.	BS 16 16 R04	1	15 Torx key 6	TK 06	1
8 Boring bar 34 mm.	BS 34 16 R04	1	16 Torx key 8	TK 08	1
9 Cartridge	BS 2CT R04	1	17 Torx key 15	TK 15	1
10 Counterweight	BS 2CW	1	18 Plate fixing screws	D 027 21	4
11 Small plate	BS SP 085 130	1	19 Cartridge screw	CS 10 25	1
12 Medium plate	BS SP 125 170	1	20 Counterweight screw	CS 08 25	1
13 Large plate	BS SP 165 210	1			

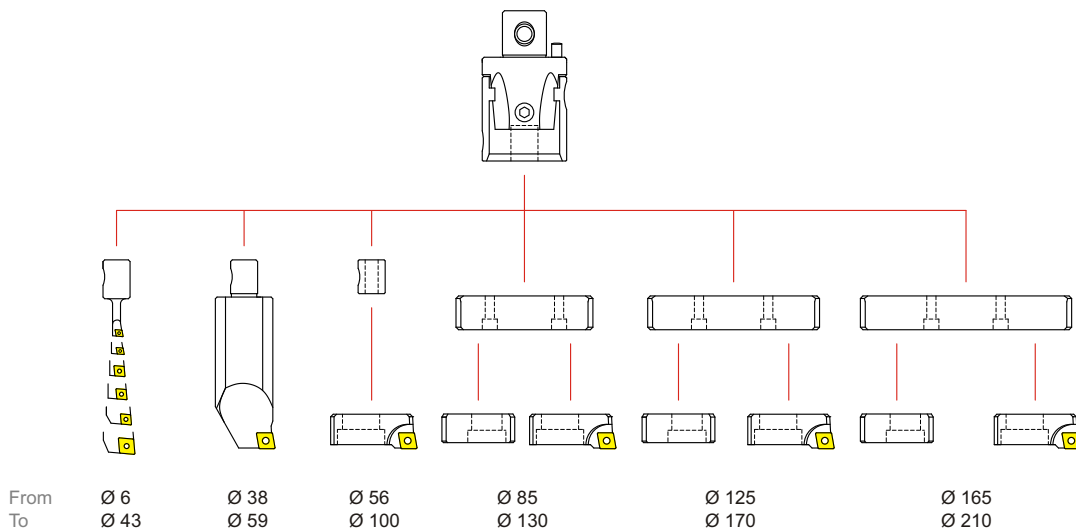

Bohrstar 54 KIT

Rhombic insert 

Ø 8 - 210

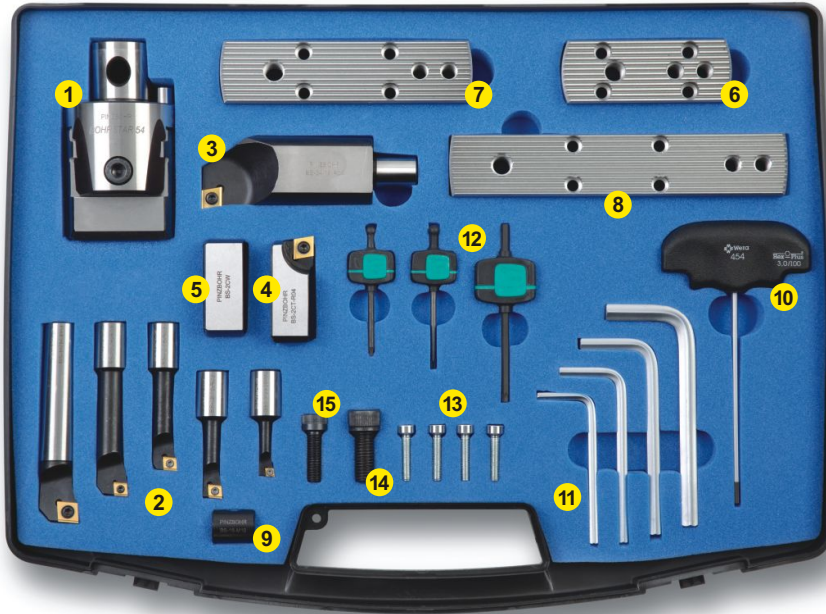

ORDERING NUMBER:
BS 54 KIT R 8-210

Description	Product Number	Qty.	Description	Product Number	Qty.
1 Bohrstar head	BS 054 16	1	9 Location sleeve	BS 16 M10	1
2 Boring bar 6 mm.	BS 06 16 R01	1	10 Adjusting key	AK 03	1
3 Boring bar 8 mm.	BS 08 16 R03	1	11 Hexagonal key 4	HK 040	1
4 Boring bar 10 mm.	BS 10 16 R03	1	12 Hexagonal key 5	HK 050	1
5 Boring bar 12 mm.	BS 12 16 R03	1	13 Hexagonal key 6	HK 060	1
6 Boring bar 16 mm.	BS 16 16 R04	1	14 Hexagonal key 8	HK 080	1
7 Boring bar 34 mm.	BS 34 16 R04	1	15 Torx key 6	TK 06	1
8 Cartridge	BS 2CT R04	1	16 Torx key 8	TK 08	1
9 Counterweight	BS 2CW	1	17 Torx key 15	TK 15	1
10 Small plate	BS SP 085 130	1	18 Plate fixing screws	D 027 21	4
11 Medium plate	BS SP 125 170	1	19 Cartridge screw	CS 10 25	1
12 Large plate	BS SP 165 210	1	20 Counterweight screw	CS 08 25	1

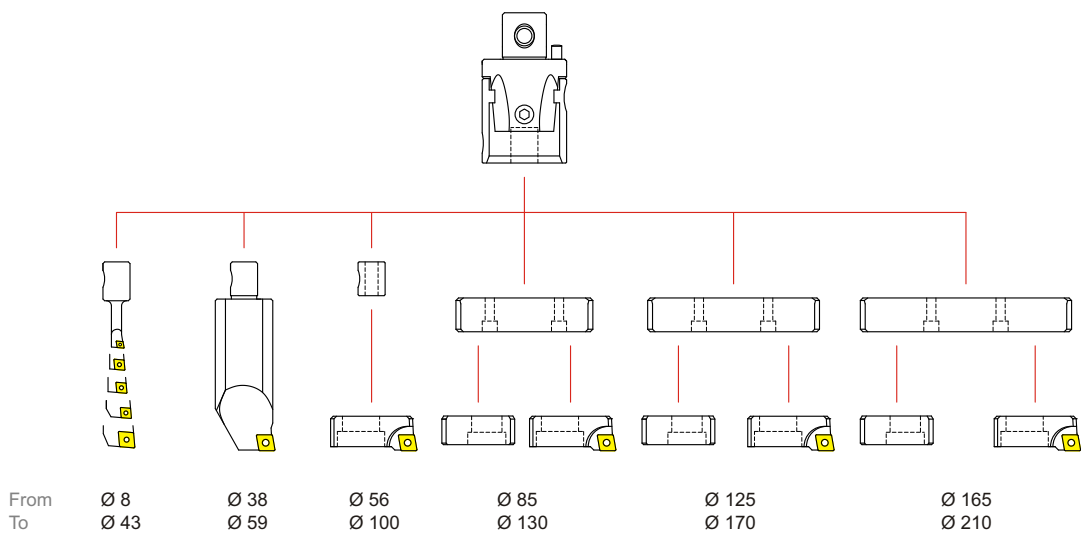

Bohrstar 54 KIT

Triangular insert 

Ø 8 - 43

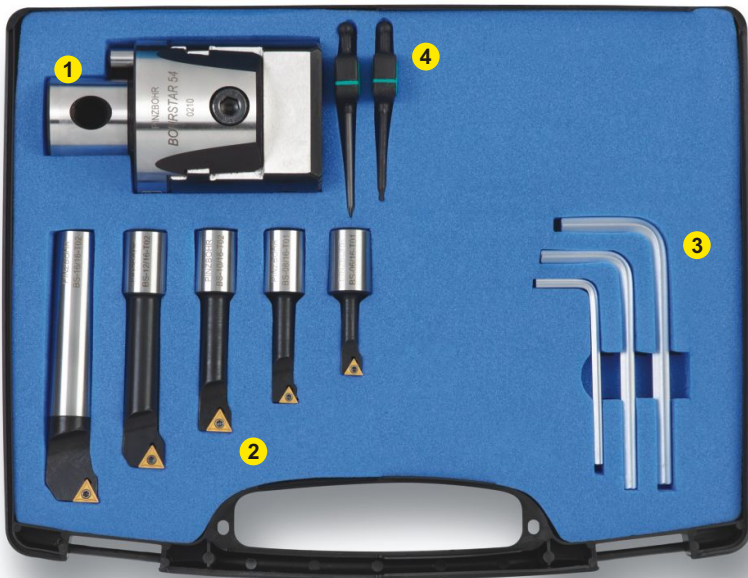

ORDERING NUMBER:
BS 54 KIT T 8-043

	Description	Product Number	Qty.
1	Bohrstar head	BS 054 16	1
	Boring bar 6 mm.	BS 06 16 T01	1
	Boring bar 8 mm.	BS 08 16 T01	1
2	Boring bar 10 mm.	BS 10 16 T02	1
	Boring bar 12 mm.	BS 12 16 T02	1
	Boring bar 16 mm.	BS 16 16 T02	1

	Description	Product Number	Qty.
3	Hexagonal key 3	HK 030	1
	Hexagonal key 5	HK 050	1
	Hexagonal key 6	HK 060	1
4	Torx key 6	TK 06	1
	Torx key 7	TK 07	1

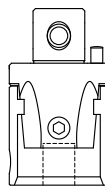

From Ø 8
To Ø 43

Bohrstar 54 KIT

Triangular insert 

Ø 8 - 100



ORDERING NUMBER:
BS 54 KIT T 8-100

	Description	Product Number	Qty.
1	Bohrstar head	BS 054 16	1
	Boring bar 6 mm.	BS 06 16 T01	1
	Boring bar 8 mm.	BS 08 16 T01	1
2	Boring bar 10 mm.	BS 10 16 T02	1
	Boring bar 12 mm.	BS 12 16 T02	1
	Boring bar 16 mm.	BS 16 16 T02	1
3	Boring bar 34 mm.	BS 34 16 T03	1
4	Cartridge	BS 2CT T03	1
5	Location sleeve	BS 16 M10	1

	Description	Product Number	Qty.
6	Hexagonal key 3	HK 030	1
	Hexagonal key 5	HK 050	1
	Hexagonal key 6	HK 060	1
	Hexagonal key 8	HK 080	1
7	Torx key 6	TK 06	1
	Torx key 7	TK 07	1
	Torx key 8	TK 08	1
8	Cartridge screw	CS 10 25	1

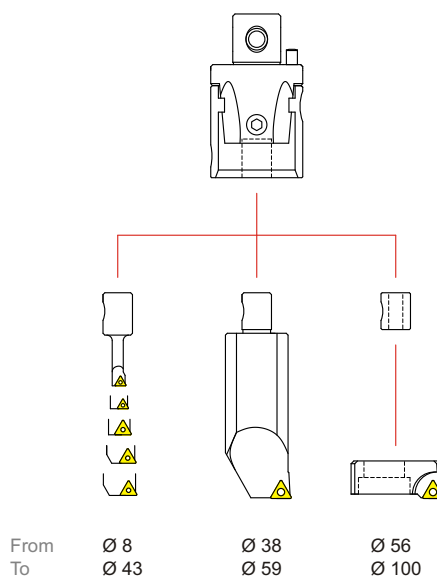

Bohrstar 54 KIT

Triangular insert 

Ø 8 - 170

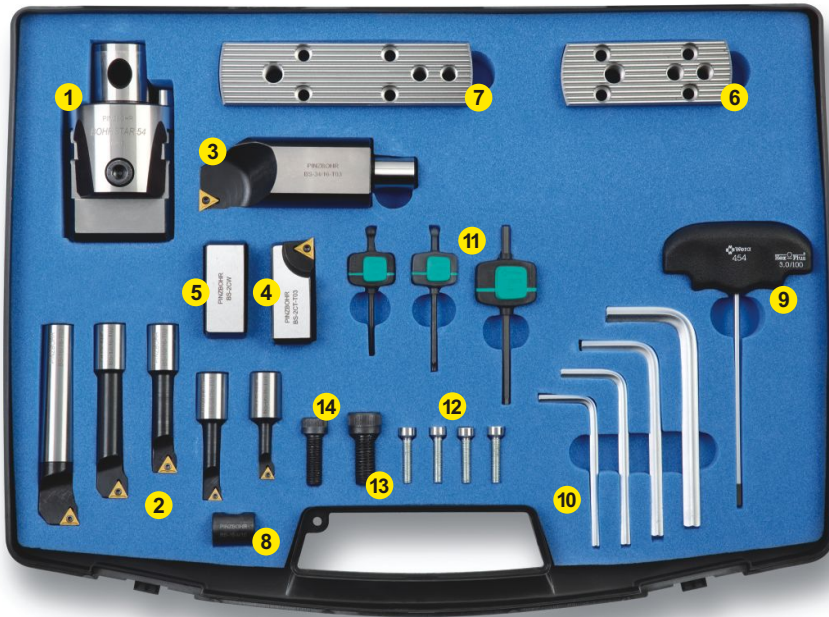

ORDERING NUMBER:
BS 54 KIT T 8-170

	Description	Product Number	Qty.
1	Bohrstar head	BS 054 16	1
	Boring bar 6 mm.	BS 06 16 T01	1
	Boring bar 8 mm.	BS 08 16 T01	1
2	Boring bar 10 mm.	BS 10 16 T02	1
	Boring bar 12 mm.	BS 12 16 T02	1
	Boring bar 16 mm.	BS 16 16 T02	1
3	Boring bar 34 mm.	BS 34 16 T03	1
4	Cartridge	BS 2CT T03	1
5	Counterweight	BS 2CW	1
6	Small plate	BS SP 085 130	1
7	Medium plate	BS SP 125 170	1
8	Location sleeve	BS 16 M10	1

	Description	Product Number	Qty.
9	Adjusting key	AK 03	1
	Hexagonal key 4	HK 040	1
	Hexagonal key 5	HK 050	1
10	Hexagonal key 6	HK 060	1
	Hexagonal key 8	HK 080	1
	Torx key 6	TK 06	1
11	Torx key 7	TK 07	1
	Torx key 8	TK 08	1
12	Plate fixing screws	D 027 21	4
13	Cartridge screw	CS 10 25	1
14	Counterweight screw	CS 08 25	1

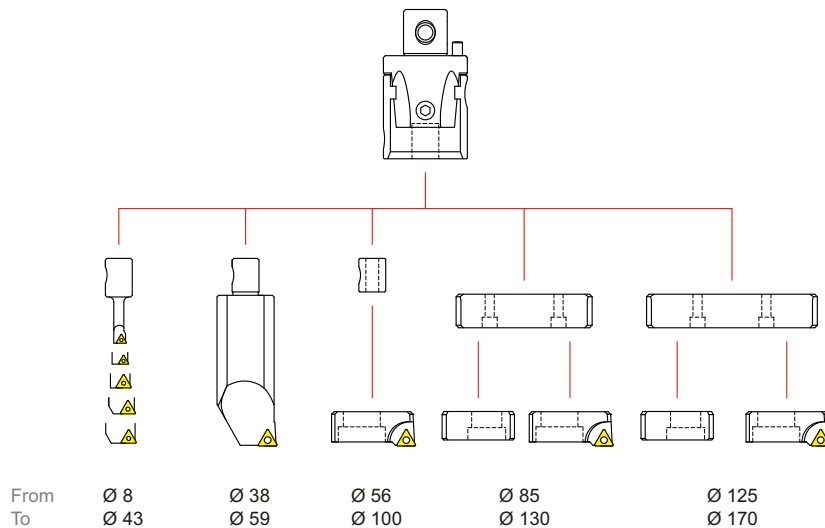

Bohrstar 54 KIT

Triangular insert 

Ø 8 - 210

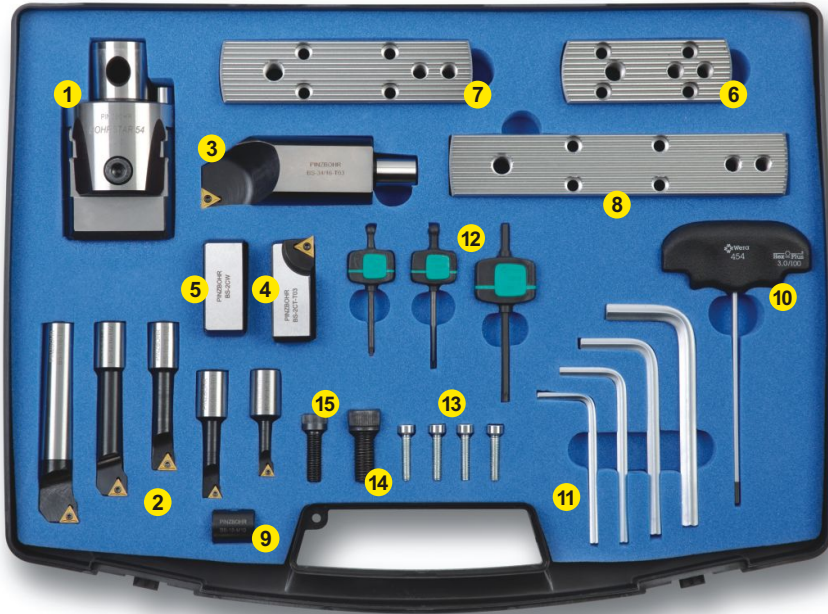

ORDERING NUMBER:
BS 54 KIT T 8-210

	Description	Product Number	Qty.
1	Bohrstar head	BS 054 16	1
	Boring bar 6 mm.	BS 06 16 T01	1
	Boring bar 8 mm.	BS 08 16 T01	1
2	Boring bar 10 mm.	BS 10 16 T02	1
	Boring bar 12 mm.	BS 12 16 T02	1
	Boring bar 16 mm.	BS 16 16 T02	1
3	Boring bar 34 mm.	BS 34 16 T03	1
4	Cartridge	BS 2CT T03	1
5	Counterweight	BS 2CW	1
6	Small plate	BS SP 085 130	1
7	Medium plate	BS SP 125 170	1
8	Large plate	BS SP 165 210	1

	Description	Product Number	Qty.
9	Location sleeve	BS 16 M10	1
10	Adjusting key	AK 03	1
	Hexagonal key 4	HK 040	1
	Hexagonal key 5	HK 050	1
11	Hexagonal key 6	HK 060	1
	Hexagonal key 8	HK 080	1
	Torx key 6	TK 06	1
12	Torx key 7	TK 07	1
	Torx key 8	TK 08	1
13	Plate fixing screws	D 027 21	4
14	Cartridge screw	CS 10 25	1
15	Counterweight screw	CS 08 25	1

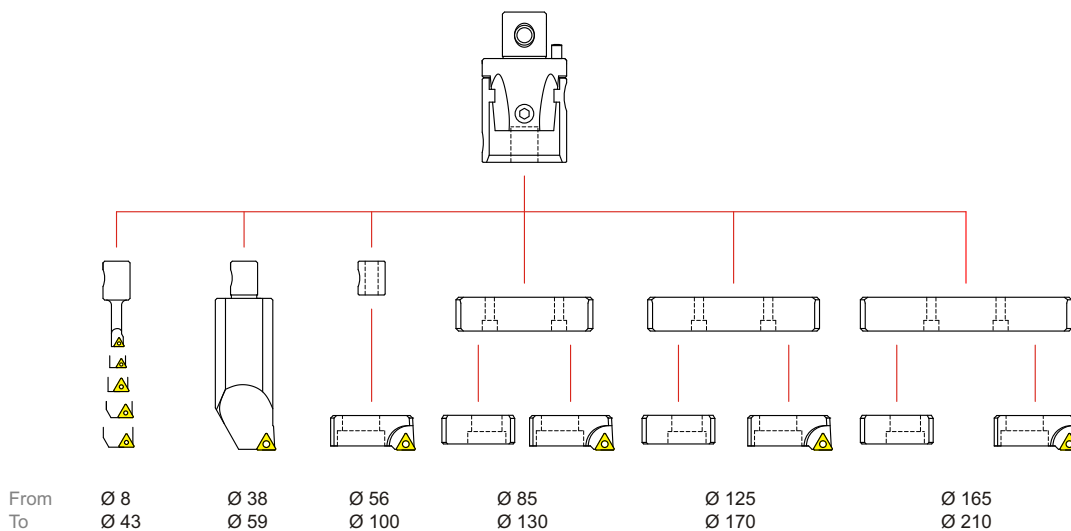

MAS BT 403



ISO 40

Dimension				Product Number	Kg.	Coupling Screw
øD	øD1	L	L1			
54	28	54	27	BT 340 054 090	1.350	54-1220
54	28	124	97	BT 340 054 160	2.610	54-1220
54	28	164	137	BT 340 054 200	3.370	54-1220

ISO 50

Dimension				Product Number	Kg.	Coupling Screw
øD	øD1	L	L1			
54	28	65	27	BT 350 054 090	4.110	54-1220
54	28	135	97	BT 350 054 160	5.400	54-1220
54	28	175	137	BT 350 054 200	6.100	54-1220

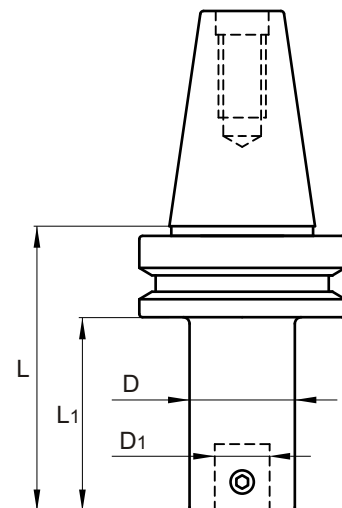

DIN 69871



ISO 40

Dimension				Product Number	Kg.	Coupling Screw
øD	øD1	L	L1			
54	28	76	57	AS 340 054 120	1.630	54-1220
54	28	116	97	AS 340 054 160	2.360	54-1220
54	28	156	137	AS 340 054 200	3.110	54-1220



ISO 50

Dimension				Product Number	Kg.	Coupling Screw
øD	øD1	L	L1			
54	28	62	27	AS 350 054 090	3.570	54-1220
54	28	132	97	AS 350 054 160	4.850	54-1220
54	28	172	137	AS 350 054 200	5.570	54-1220

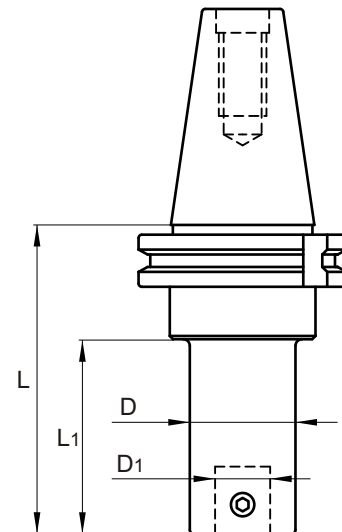

DIN 2080

OTT

ISO 40

Dimension				Product Number	Kg.	Coupling Screw
$\varnothing D$	$\varnothing D_1$	L	L ₁			
54	28	39	27	OTT 340 054 090	1.100	54-1220
54	28	109	97	OTT 340 054 160	2.370	54-1220
54	28	149	137	OTT 340 054 200	3.140	54-1220



ISO 50

Dimension				Product Number	Kg.	Coupling Screw
$\varnothing D$	$\varnothing D_1$	L	L ₁			
54	28	43	27	OTT 350 054 090	3.100	54-1220
54	28	113	97	OTT 350 054 160	4.380	54-1220
54	28	153	137	OTT 350 054 200	5.100	54-1220

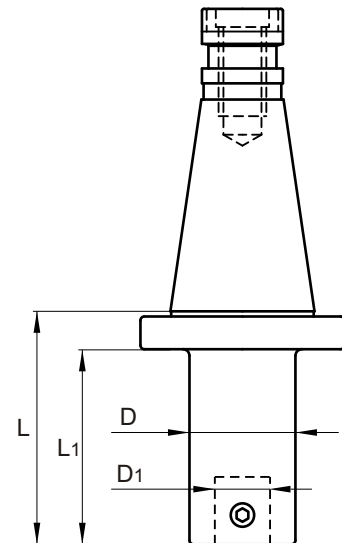

DIN 69893



HSK 63

Dimension				Product Number	Kg.	Coupling Screw
$\varnothing D$	$\varnothing D_1$	L	L ₁			
54	28	70	44	HSK 063A 054 110	1.300	54-1220



HSK 100

Dimension				Product Number	Kg.	Coupling Screw
$\varnothing D$	$\varnothing D_1$	L	L ₁			
54	28	73	44	HSK 100A 054 110	2.800	54-1220

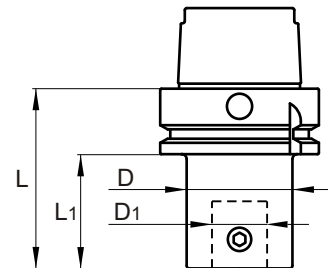

Boring head

Adjusting accuracy 0.002 mm Ø

Dimension				Product Number	Kg.
øD	øD1	øD2	L		
54	28	16	65	BS 054 16	1.100

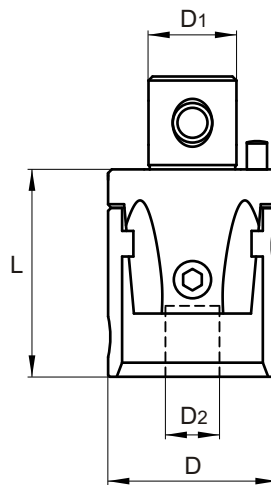

Accessories (Optional)

EXTENSIONS

FOR DEEPER HOLE APPLICATIONS

Dimension				Product Number	Kg.	Coupling Screw
øD	øD1	øD2	L			
54	28	28	50	P 054 050	0.880	54-1220
54	28	28	75	P 054 075	1.320	54-1220

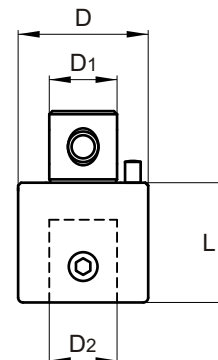

REDUCERS

TO USE ON BIGGER DIAMETER PINZBOHR ARBORS

Dimension						Product Number	Kg.	Coupling Screw
øD	øD1	øD2	øD3	L	L1			
68	36	54	28	60	12	R 068 054 072	1.520	54-1220
85	50	54	28	78	12	R 085 054 090	2.460	54-1220

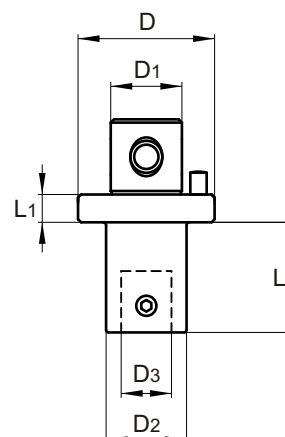

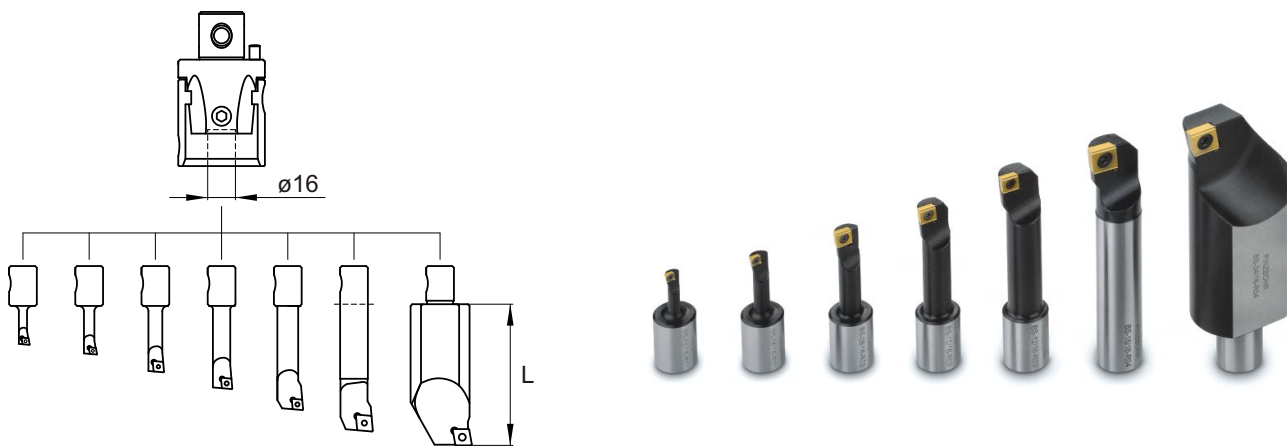

RHOMBIC INSERT

Bore Range		L	Product Number	Insert	Kg.	Clamp Screw	Clamp Key
Min	Max						
6	28	20	BS 05 16 R01	EP□□ 0401□□ L	0.045	M2X3.3	TK 06
8	30	25	BS 06 16 R01	EP□□ 0401□□ L	0.046	M2X4	TK 06
8	30	25	BS 06 16 R02	EP□□ 0502□□	0.046	M2.2X5.6	TK 07
10	32	35	BS 08 16 R03	CC□□ 0602□□	0.054	M2.5X4.8	TK 08
13	35	45	BS 10 16 R03	CC□□ 0602□□	0.068	M2.5X6	TK 08
16	38	57	BS 12 16 R03	CC□□ 0602□□	0.090	M2.5X6	TK 08
20	43	73	BS 16 16 R04	CC□□ 09T3□□	0.145	M4X8.5	TK 15
38	59	82	BS 34 16 R04	CC□□ 09T3□□	0.450	M4X8.5	TK 15

TRIANGULAR INSERT

Bore Range		L	Product Number	Insert	Kg.	Clamp Screw	Clamp Key
Min	Max						
8	30	25	BS 06 16 T01	TC□□ 06T1□□	0.046	M2X4.9	TK 06
10	32	35	BS 08 16 T01	TC□□ 06T1□□	0.054	M2X4.9	TK 06
13	35	45	BS 10 16 T02	TC□□ 0902□□	0.068	M2.2X6.4	TK 07
16	38	57	BS 12 16 T02	TC□□ 0902□□	0.090	M2.2X6.4	TK 07
20	43	73	BS 16 16 T02	TC□□ 0902□□	0.145	M2.2X6.4	TK 07
38	59	82	BS 34 16 T03	TP□□ 1102□□	0.450	M2.5X6	TK 08
38	59	82	BS 34 16 T04	TC□□ 16T3□□	0.450	M4X8.5	TK 15

► All inserts for this programme are available in our stock.

RHOMBIC INSERT

H	L	Product Number	Insert	Kg.	Clamp Screw	Clamp Key
20	51	BS 2CT R04	CC□□ 09T3□□	0.100	M4X8.5	TK 15

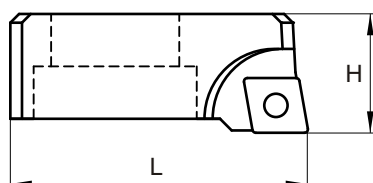

TRIANGULAR INSERT

H	L	Product Number	Insert	Kg.	Clamp Screw	Clamp Key
20	51	BS 2CT T03	TP□□ 1102□□	0.100	M2.5X6	TK 08
20	51	BS 2CT T04	TC□□ 16T3□□	0.100	M4X8.5	TK 15

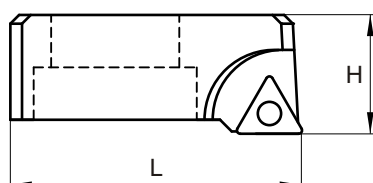

► All inserts for this programme are available in our stock.

Counterweight

H	L	Product Number	Kg.
18.5	47	BS 2CW	0.110

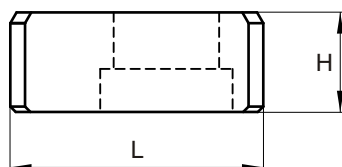

SMALL PLATE

H	L	Product Number	Kg.
20	81	BS SP 085 130	0.105

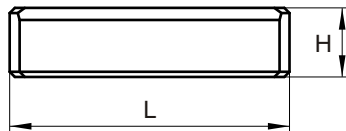
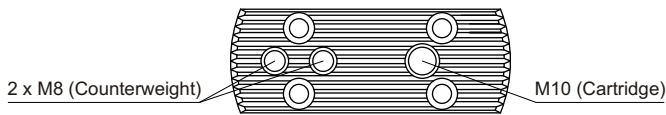

MEDIUM PLATE

H	L	Product Number	Kg.
20	121	BS SP 125 170	0.170

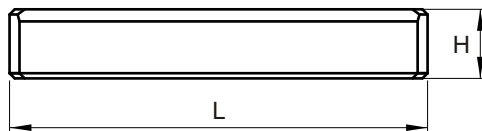
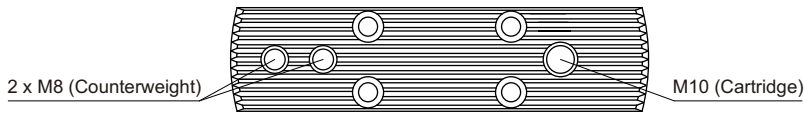

LARGE PLATE

H	L	Product Number	Kg.
20	161	BS SP 165 210	0.230

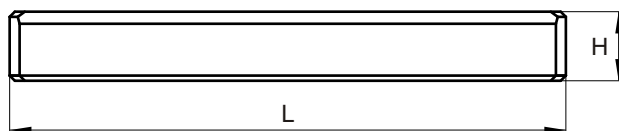
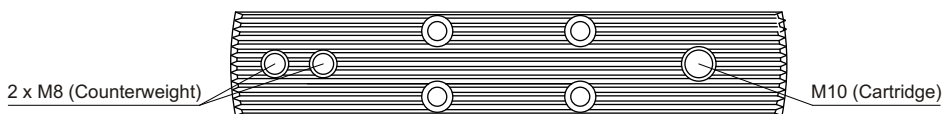



*Several hole solutions
with only one boring head*

Distributed by: